



ELOTECH
INDUSTRIELELEKTRONIK

R4000

Temperature Controller with

1, 2, 4, 6, 8, 12* or 16* zones Heating/Cooling

* With the extension module R4010 up to 16 zones can be connected.



Depth: 122mm

Format: 96mm x 96mm

DESCRIPTION AND OPERATING MANUAL

ELOTECH Industrieelektronik GmbH

Verbindungsstraße 27

D - 40723 HILDEN

FON +49 2103 / 255 97 0

www.elotech.de

FAX +49 2103 / 255 97 29

Email: info@elotech.de

Contents

Contents.....	2
1 General Information	3
2 Installation Instructions	3
3 Type Code	4
4 Connection Diagram	5
4.1 Connection Diagram: Power supply, Logic Inputs and Heater Current	5
4.2 Connection Diagram: Monitoring Relay	6
4.3 Connection Diagram: Sensor Inputs	6
4.4 Connection Diagram: Logic Outputs	6
4.5 Connection Diagram: Relay Outputs	7
4.6 Connection diagram Continuous outputs (option)	7
4.7 Connection diagram E-Bus for extension module	7
4.8 Connection Diagram: Fieldbus Interfaces	8
4.9 Connection Diagram: LAN and USB	8
5 Display and Keyboard	9
5.1 Window-Overview	9
5.2 Display screens (Windows)	10
5.2.1 Window: Actual Process Values	10
5.2.2 Window: Main	12
5.2.3 Window: Zone synopsis	13
5.2.4 Window: Monitoring display	14
5.3 Adjusting windows	15
5.3.1 Window: Entering number value	15
5.3.2 Window: Selection with tiles	16
5.3.3 Window: Selection List view	16
5.3.4 Window: Saving to multiple zones	17
5.3.5 Window: Setting text	17
5.4 More display screens (more Windows)	18
5.4.1 Window: Process	18
5.4.2 Window: Graph	18
5.4.3 Window: Log (Logbook)	19
5.4.4 Window: Program (Program controller graph)	19
5.4.5 Window: Program controller Selection/Setting	20
5.4.5.1 Procedure of the program control:	22
5.4.6 Window: Parameter	23
5.4.7 Zone – Parameter list	23
5.4.7.1 Menu: Heating Control Parameter	25
5.4.7.2 Menu: Cooling Control Parameter	26
5.4.7.3 Ramps: Ramp rising / Ramp falling	27
5.4.7.4 Menu: Softstart	27
5.4.7.5 Menu: Limit values	28
5.4.7.6 Menu: Sensor settings	29
5.4.7.7 Control outputs	30
5.4.8 Window: Tools	31
5.4.8.1 Configuration Monitoring 1+2	31
5.4.8.2 Configuration Limit 1+2	32
5.4.8.3 Wizard	33
5.4.8.4 Field Bus / USB / LAN	34
5.4.8.5 Configuration Current alarm (option)	37
5.4.9 Window: System	38
5.4.9.1 Settings	39
5.4.9.2 About / → Firmware update	40
5.4.9.3 Configuration Indicator/Controller	41

5.4.9.4	Configuration Units.....	41
5.4.9.5	Configuration sensors	42
5.4.9.6	Configuration Output digital	43
5.4.9.7	Configuration Output relay	43
5.4.9.8	Configuration of continuous outputs (option)	43
6	Error Messages	44
7	Technical Data	45

1 General Information

Symbols used:

www.elotech.de	Messages shown by the controller are written in this font.
MRS / MRE	M easuring R ange S tart / M easuring R ange E nd
<§>	Symbolizes the factory adjustment of the respective parameters.

2 Installation Instructions

Make sure the device is used for the intended purpose only.

R4000 controllers are designed for installation in control panels.
Protect the device against impermissible humidity and contamination.

The permitted ambient temperature range may not be exceeded.
Electrical connections must be made according to valid regulations and by properly qualified personnel.

If using thermocouple sensors, compensation lines have to be connected directly to the controller terminals. Sensors may be connected only in compliance with the programmed range.

Sensor cables and signal lines (e.g. logic or linear voltage outputs) must be laid separately from control lines and mains voltage supply cables (power cables).

In order to maintain CE-Compliance screened detectors - and signal lines have to be used. It is not permitted to connect the grounds of the sensor-inputs and logic-outputs with each other.

Separate installation of controller and inductive loads is recommended.
Interference from contactor coils must be suppressed by connecting adapted RC-combinations parallel to the coils.
Control circuits (e.g. for contactors) should not be connected to the mains power supply terminals of the controller.

The configuration parameters (Window: System) are generally to be selected first.

Disclaimer of Liability

The contents of this document is checked for the conformity with the hardware and software described. Nevertheless, we are unable to preclude the possibility of deviations so that we are unable to assume warranty for full compliance. However, the information given in the publication is reviewed regularly. Necessary amendments are incorporated in the following editions.

We would be pleased to receive any improvement proposals which you may have.

The information contained herein is subject to change without notice.

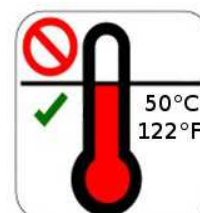

Electronic scrap and components are subject to special treatment and must be disposed of by authorised companies.

3 Type Code

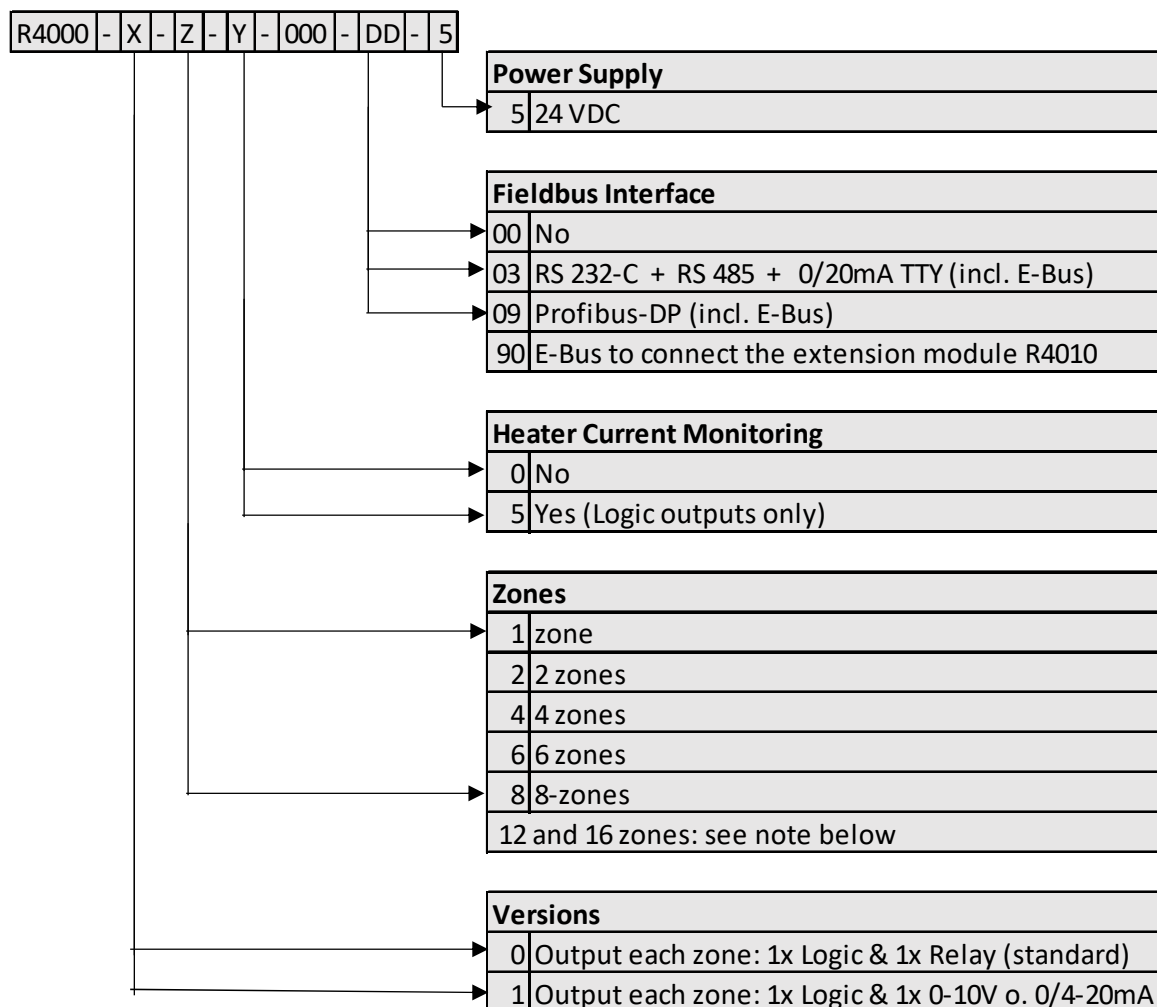

DD If 12 or 16 zones are required, an 8-zone controller and an expansion module R4010 (4 or 8 zones) must be ordered.

The E-bus on the R4000 is required for communication with the R4010.

If the required controller already has a fieldbus interface, then the E-bus interface is already available.

If no fieldbus interface is required, key 90 (E-bus) must be selected for the fieldbus.

4 Connection Diagram

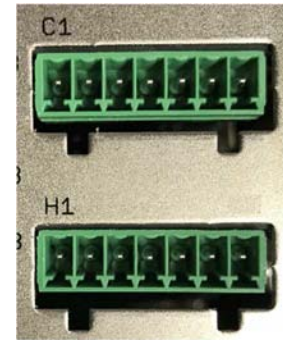
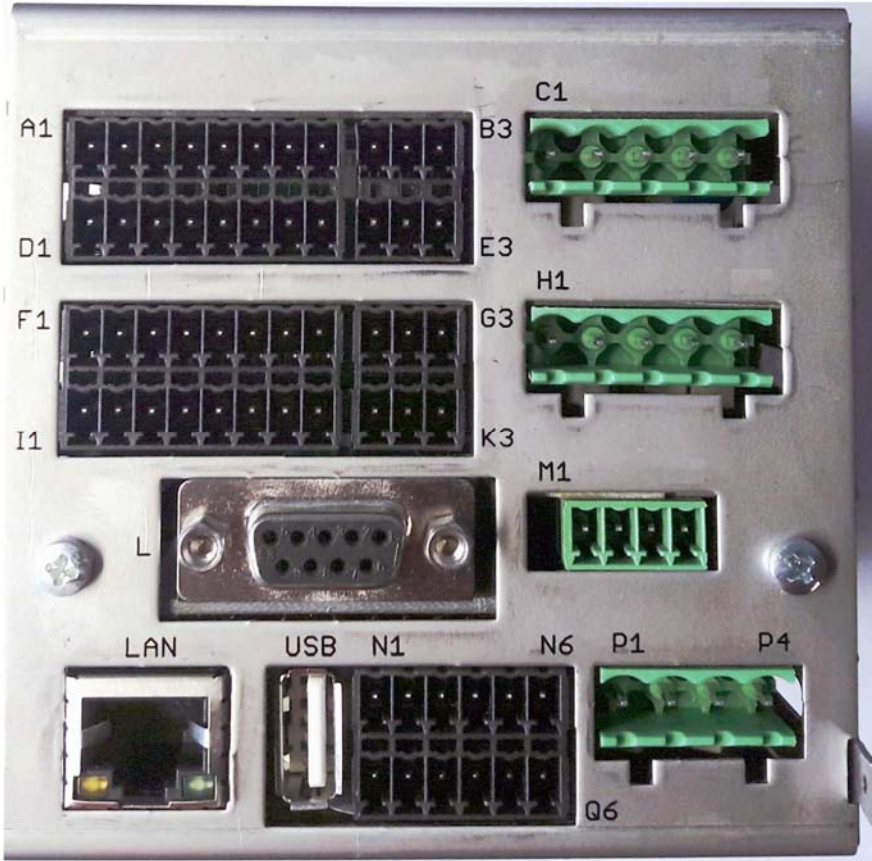

Option continuous

Ground connection

The Ground connection (flat plug 6,3mm) must be connected to an earth rail via a thick cable ($\geq 4\text{mm}^2$) in the shortest possible way ($< 20\text{cm}$)!

4.1 Connection Diagram: Power supply, Logic Inputs and Heater Current

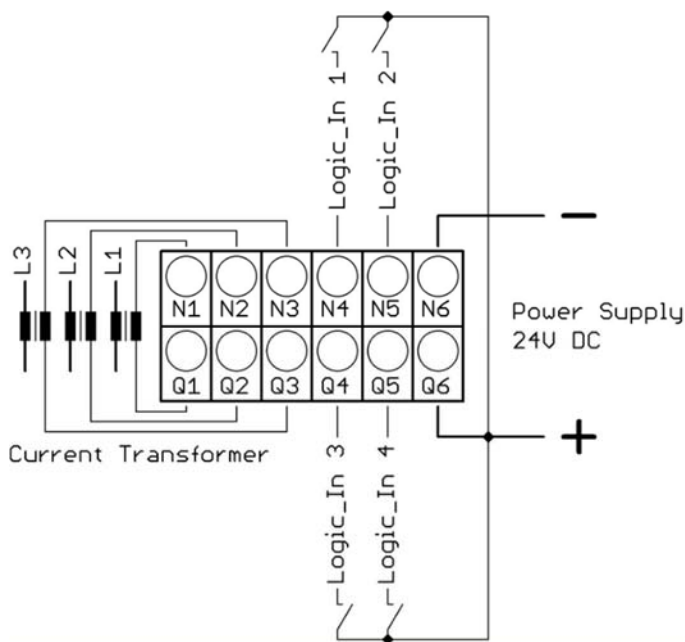

Function of the logic inputs:

In_1: 0 = Setpoint 1 active for all zones.
1 = Setpoint 2 active for all zones.

In_2: 0 = Parameter "Authorisation" is adjustable.
1 = Parameter "Authorisation" is not adjustable.

In_3: no function

In_4: no function

4.2 Connection Diagram: Monitoring Relay

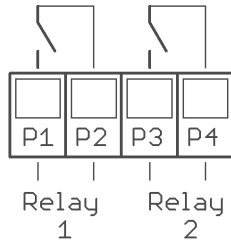

4.3 Connection Diagram: Sensor Inputs

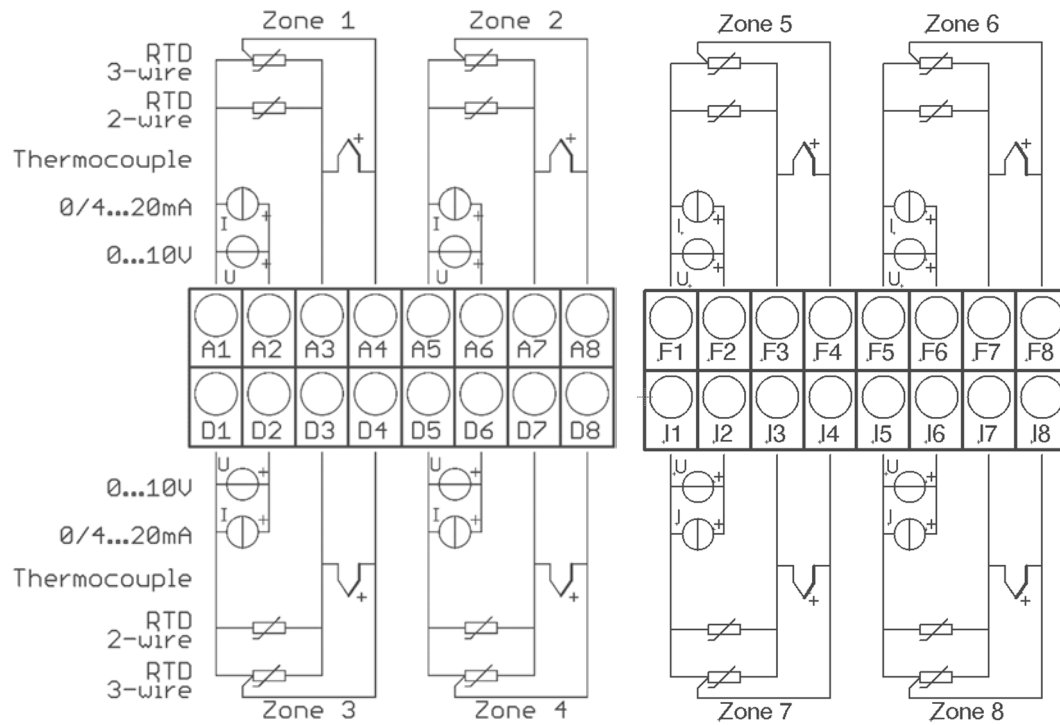

It is not permitted to connect the grounds of the sensor-inputs and logic-outputs with each other!

RTD/Ni120: The parameter "Sensor Settings / Sensor" has to be set accordingly to the connection diagram (2-wire/3-wire)

4.4 Connection Diagram: Logic Outputs

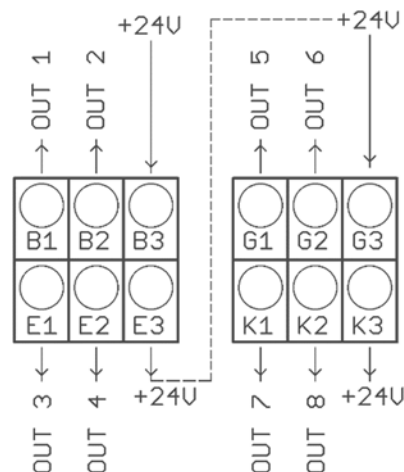

The power supply for the logic outputs has to be wired externally:

+24V have to be applied to the terminals B3 and G3.

B3 is connected internally to E3 and G3 is connected to K3. So the terminals E3 and K3 can be used to loop the +24V.

The 24V are switched to the outputs out x and thus control the SSRs. Reference potential is the ground of the supply voltage.

4.5 Connection Diagram: Relay Outputs

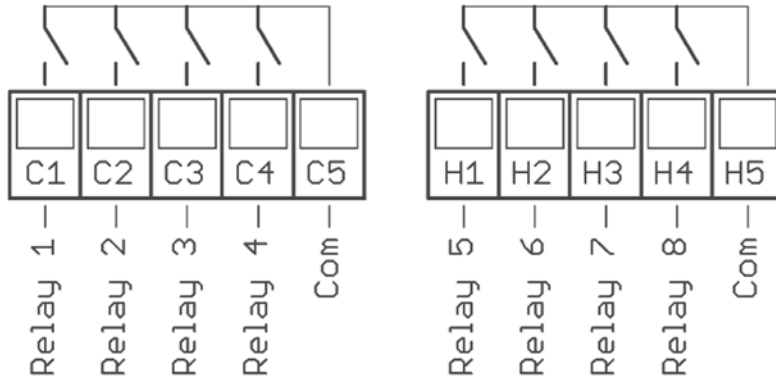

4.6 Connection diagram Continuous outputs (option)

If continuous outputs are existed, the relay outputs are not available.

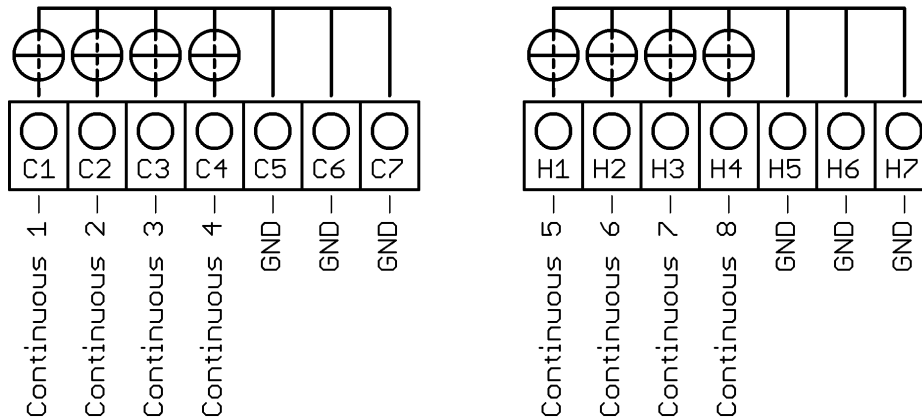

The GND connection terminals C5 - C7 and H5 - H7 are bridged. The output automatically switches to current or voltage, depending on the connected load.

4.7 Connection diagram E-Bus for extension module

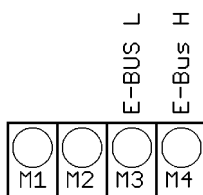

The extension module R4010, for extension to 12 or 16 zones, is connected to the R4000 via the E-bus.

The lines „E-Bus L” and E-Bus H” must be connected to the corresponding terminals of the R4010.

The connection must be designed as a shielded cable. The shield has to be connected to the earth (housing) at the R4010 side.

4.8 Connection Diagram: Fieldbus Interfaces

Type 03 / 07 : Serial Interface / CAN

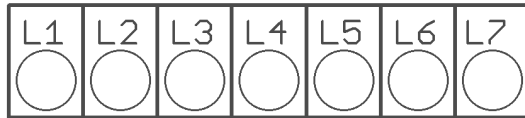

							Bus	Type	Remark
	A	B					RS485	03	Parameter HW-config = RS232 / RS485
			RxD	TxD	GND		RS232	03	Parameter HW-config = RS232 / RS485
					-	+	TTY	03	Parameter HW-config = TTY (current loop)
	H	L					CAN	07	Not available at the moment

The serial fieldbus module (Type: 03) contains the three interfaces RS232, RS485 und TTY. By choosing the connection and setting the parameter "HW-config" the desired bus is selected.

Typ 09: Profibus

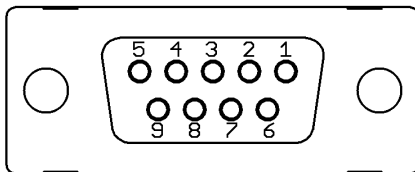

Pin 3	Data RxD / TxD - P
Pin 5	GND
Pin 6	+5V
Pin 8	Data RxD / TxD - N

The 5V-Supply is designed for the supply of the termination resistors. Further loads are not allowed.

4.9 Connection Diagram: LAN and USB

USB: Save process data, configuration data and alarm data on an USB-Stick.
Write back configuration data from USB-Stick to the controller.
Make a firmware update. (Please use FAT formatted USB flash drives.)

LAN: Connection to configuration tool **EloVision 3**.
Read and write parameters by MODBUS-TCP protocol.

5 Display and Keyboard

The device is equipped with a backlight colour LC-display.

After switching on the controller and completion of the initialization, the actual process values and setpoints of all connected zones are displayed.

The device is operated by menus. The different parameters are displayed mainly in plain text and can be displayed in various languages.

There are several windows for different functions and settings.

5.1 Window-Overview

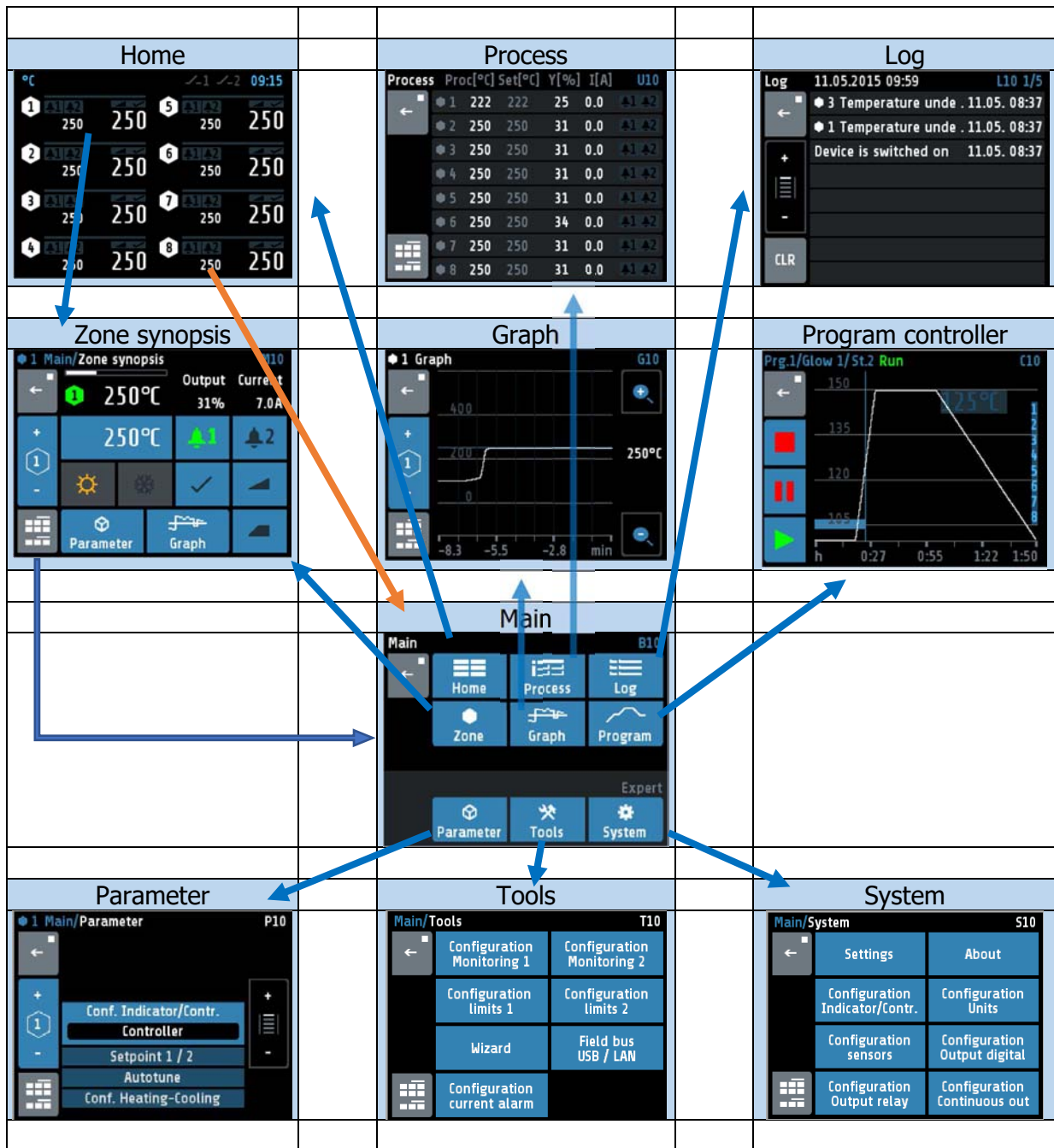

→ = Hold down the key (> 1 s)

5.2 Display screens (Windows)

5.2.1 Window: Actual Process Values

Display of setpoints and actual process values of all connected zones.

	<p>The header displays on the left the current unit, here °C. The top right shows the time.</p>
	<p>The hexagon displays the zone number. If the zone is turned off, the actual process value displays "OFF", here seen in zone 5, and the hexagon shows the number of the zone is grey.</p>
	<p>For every zone the actual process value is written in large and the setpoint in small numbers.</p>
	<p><- 1 zone controller</p> <p>With the 1-6 zone controllers, the zone designation is displayed above the line. Here e.g. "Tank 1".</p>
	<p><- 2 zone controller</p>
	<p><- 4 zone controller</p>

	<p><- 6 zone controller</p>
	<p>12/16-zone controller: (in conjunction with 12/16-zone expansion module) The structure is similar to the picture of the 8-zone controller. Below the zones are 2 buttons (+ / -) for switching the zones (1 ... 8) to (9 ... 16) and back.</p>
	<p>Monitoring 1 of zone 4 is active.</p>
	<p>Zone 4 is set as the display zone. Unit bar. Monitoring 1 is active.</p>
	<p>Monitoring 2 of zone 8 is active. At this point the signal has an enable function. Therefore the colour green was chosen.</p>
	<p>Ramp is active.</p>
	<p>Soft start function is active.</p>
	<p>Auto tune is active.</p>
	<p>Setpoint 2 is active. "SP2" in the header indicates that setpoint 2 is activated. If setpoint 2 is set in a zone, this zone is set to this setpoint 2 when logic input In_1 is closed. Zones with setpoint 2 set to "OFF" are not switched over.</p>
	<p>Contact of Monitoring relay 1 is closed. Contact of Monitoring relay 2 is open.</p>
	<p>Tapping the area of the zone, here zone 2, leads to the next menu. A grey frame and blue zone symbols show up while pressing the key. Briefly pressing the key leads to the zone overview. Holding down the key (>1s) leads to the main.</p>

5.2.2 Window: Main

This window contains a summary of the other function windows.

	<p>One gets to this window by pressing the area of a selected zone in the window "Actual Process Value" for more than 1 seconds.</p> <p>Likewise, you come into this window by pressing the following icon. In different windows this symbol appears in the lower left corner.</p>
	<p>Jump to window "Actual Process Value" Display for all zones: Actual process value, setpoint, output ratio, alarms, ramp, autotune, softstart</p>
	<p>Jump to window "Zone synopsis" Display and entry for selected zone: Actual process value, setpoint, output ratio, current, monitoring state, ramp, autotune, softstart</p>
	<p>Jump to window "Process" (List view) Display for all zones: Actual process value, setpoint, output ratio, current, monitoring state</p>
	<p>Jump to window "Graph" Display for selected zone: Graphical display of the actual value process-temperature over time</p>
	<p>Jump to window "Log" Display for all zones: Alarm- und status messages</p>
	<p>Jump to window "Program controller" Graphical representation of the temperature profile with start / stop button and possibility of configuring the programs.</p>
	<p>Jump to window "Parameter" Display and entry for all zones: All zone-parameter</p>
	<p>Jump to window "Tools" Configuration of the monitoring, the alarms and interfaces. (USB, Fieldbus, LAN) Calling of the Wizard (set-up assistance)</p>
	<p>Jump to window "System" Configuration inputs, outputs, Indicator/Controller and unit. Setting language, date, sample time and restart lock-out.</p>
	<p>Hold down < 1 sec. = Return to previous window Hold down > 1 sec. = Jump to window "Actual Process Value"</p>

5.2.3 Window: Zone synopsis

This window contains the most important information of the selected zone.
The window appears after the area of the zone in the window "Actual Process Value" has been briefly pressed.

	<p>The currently set zone is displayed on the left and the zone name "Tank 1" on the right in the header.</p>
	<p>Shown is the current setpoint. When editing the setpoint the blue area has to be pressed.</p>
	<p>Setpoint 2 is active. To set the setpoint value 2, press this blue field and confirm the following warning message with Yes.</p>
	<p>Display of monitoring 1. Grey = signal not active. Colored = signal active Pressing the area leads to the window "Monitoring display". The same applies to monitoring 2.</p>
	<p>Output ratio shown as bar. White bar: positive output ratio (heating). Blue bar: negative output ratio (cooling).</p>
	<p>Autotune: grey = not active, orange = active Pressing the area leads to the window "Autotune"</p>
	<p>Ramp: grey = not active, orange = active Pressing the area leads to the window "Ramp rising/falling"</p>
	<p>Softstart: grey = not active, orange = active Pressing the area leads to the window "Softstart"</p>
	<p>Heating: grey = Heater switched off, orange = Heater switched on.</p>
	<p>Cooling: grey = Cooler switched off, blue = Cooler switched on</p>
	<p>"+" switchover to the next zone. Display of the current zone number "- " switchover to the previous zone.</p>
	<p>Jump to window "Main"</p>
	<p>Jump to window "Parameter"</p>
	<p>Jump to window "Graph"</p>

5.2.4 Window: Monitoring display

	<p>In the header the currently selected zone is shown.</p> <p>The key "configuration Moni x / Alarm" leads to the configuration of monitoring and alarms. See chapter 5.4.8.1</p> <p>The key "Log" leads to the alarm logbook for further information regarding the occurred alarms</p>
	<p>The light blue background and the coloured frame shows that the event "Limit 1 exceeded" has triggered the monitoring. In case the event needs an acknowledgement, it must be done by pressing the button. Other monitoring events show "Limit reached" and "Limit undershot".</p>
	<p>The dark blue background shows that the event "Sensor error" is programmed for triggering the monitoring. The event is not active.</p>
	<p>The dark grey background shows that the event "System error" is not programmed for triggering the monitoring. In case of a system error the monitoring will not be active.</p>
	<p>"+" switchover to the next zone. Display of the current zone number "-" switchover to the previous zone.</p>
	<p>Jump to window "Main"</p>
	<p>Return to previous window</p>

5.3 Adjusting windows

5.3.1 Window: Entering number value

This window helps entering number values, here for the setpoint 1.

	<p>The header displays the current zone and the name of the Parameter, here "Setpoint 1".</p> <p>By pressing the number keys the value of the parameters can be entered. In order to take over the parameter value, it must be saved by pressing the "SAVE"- key.</p>
	<p>The value, entered by pressing the number keys, is now displayed within the blue frame.</p> <p>Underneath, on the left the unit is shown and the previous value is displayed on the right (250). The allowed range is displayed at the bottom (0..800).</p>
	<p>If this Button is visible, two adjustable parameters are available. Such as: Setpoint: 1 / 2 or Ramp: rising / falling Switch over by pressing this button. The name of the actual parameter is displayed in the header. After adjusting one parameter the window will not be closed and the second parameter can be adjusted.</p>
	<p>This key is visible when the parameter has a valid value "OFF". "OFF" can be selected like a number key.</p>
	<p>Number key</p>
	<p>Key to enter "Minus" or "Comma". The minus sign can be pressed before entering a number. After the first number was entered the key automatically changes to comma.</p>
	<p>Delete last character</p>
	<p>Return to previous window</p>
	<p>Saving of what has been entered and return to previous window. By pressing "SAVE" for > 1s., a selection window appears, in which parameter values can be saved for other zones simultaneously. See 5.3.4 Window: Saving to multiple zones.</p>

5.3.2 Window: Selection with tiles

	<p>The header displays the zone number and the parameter name on the left, here "Conf. Indicator/Contr.".</p> <p>By pressing the tile key, the element can be selected. Black text on a white background is used to display the selected element.</p> <p>In order to save the parameter value, the "SAVE"-key needs to be pressed.</p>
	<p>Selected element.</p>
	<p>Not selected element.</p>
	<p>"+" switchover to the next zone. Display of the current zone number "-" switchover to the previous zone.</p>
	<p>Saving of selection and return to previous window. When pressing "SAVE" for >1s a selection window opens up, in which the parameter value can be saved onto other zones simultaneously. See 5.3.4 Window: Saving to multiple zones</p>
	<p>Return to previous window</p>

5.3.3 Window: Selection List view

	<p>The header displays the zone and the parameter name, here "Zone On/Off".</p> <p>The actual value is displayed in the middle with light blue background. By pressing the +/- Buttons on the right (or pressing the upper or lower areas of the list) the list can slide up or down.</p> <p>In order to save the parameter value, the "SAVE"-key needs to be pressed.</p>
	<p>"+" switchover to the next zone. Display of the current zone number " - " switchover to the previous zone.</p>
	<p>Saving of selection and return to previous window When pressing "SAVE" for >1s a selection window opens up, in which the parameter value can be saved onto other zones simultaneously. See 5.3.4 Window: Saving to multiple zones</p>
	<p>Return to previous window</p>

5.3.4 Window: Saving to multiple zones

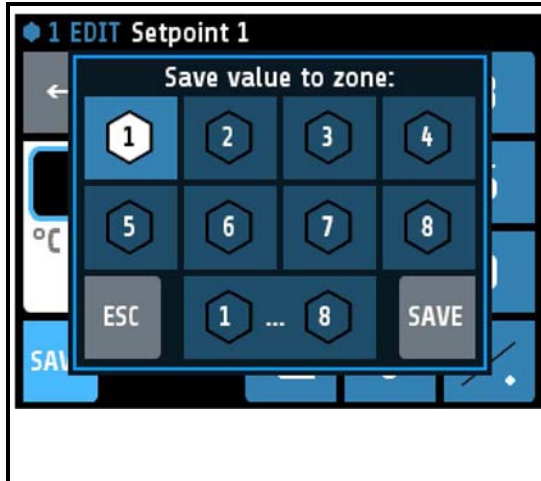

The zone (here 1) that now has to be saved is selected and cannot be deactivated.

By tapping the relevant zone field another zone can be added or deleted.

Black number on white symbol means "Zone chosen to be saved"

The lowest key "1...8" selects all zones at the same time.

"ESC" closes the window without saving.

"SAVE", saves the adjusted parameter value for all zones selected and closes the window.

5.3.5 Window: Setting text

This window is used to enter text for description of program names.



The header displays the actual program number and the actual program name.

By pressing the number keys „0 ... 9“ the new text can be entered. To set the following letters "ABC1" you have to press the key more times.

After one second the character is taken over and the next character can be entered.

In order to take over the new text, it must be saved by pressing the "SAVE"- key.



The new text is displayed in the blue/white frame.



Delete last character.



Delete all characters.



Key for setting the text. Repeated pressing changes to the next character. Here "A B C 2 Ä"



Switching case sensitive. Capital and small letters.



Return to previous window



Saving of the new text and return to previous window.

5.4 More display screens (more Windows)

5.4.1 Window: Process

This window displays an overview of all zones.

Process	Proc[°C]	Set[°C]	Y[%]	I[A]	U10	
1	250	250	39	0.0	▲1 ▲2	Six columns display the following for all zones: 1. Zone number 2. Actual Process Value (Proc[°C]) 3. Actual Setpoint (Set[°C]) 4. Output ratio (Y[%]) 5. Heater current (I[A]) 6. Monitoring 1+2 (bell symbols)
2	100	100	100	0.0	▲1 ▲2	
3	250	250	39	0.0	▲1 ▲2	
4	250	250	39	0.0	▲1 ▲2	
5	250	250	21	0.0	▲1 ▲2	
6	250	250	39	0.0	▲1 ▲2	
7	250	250	39	0.0	▲1 ▲2	
8	250	250	-11	0.0	▲1 ▲2	

	Display of Monitoring 1 (2). Grey = signal not active. Coloured = signal active
	Hold down < 1 sec. = Return to previous window Hold down > 1 sec. = Jump to window "Actual Process Value"
	Jump to window "Main"

5.4.2 Window: Graph

This window shows the temperature progression for one selected zone.

In the case of a technical incident the actual process value can still be examined afterwards.

	<p>On the right the actual process value is shown, here 250°C.</p> <p>By pressing the loupe keys „+“ and „-“ the resolution of the temperature axis can be altered.</p> <p>The time axis can be determined by the parameter "Graph sampling time" in the window "System/Settings".</p> <p>Turning off the device causes deletion of the values.</p>
	<p>"+" switchover to the next zone. Display of the current zone number "- " switchover to the previous zone.</p>
	<p>Hold down < 1 sec. = Return to previous window Hold down > 1 sec. = Jump to window "Actual Process Value"</p>
	<p>Jump to window "Main"</p>

5.4.3 Window: Log (Logbook)

This window displays alarm- and status messages for all zones.

	<p>The header displays the current date and time, the window number and page.</p> <p>Pressing the log-texts displays the full text if it is abbreviated in the normal display. See also 1)</p> <p>The logbook can take up to 40 entries. The latest entry can be found on page 1/5. If 40 entries exist already, the oldest entry will be deleted.</p> <p>The logbook is stored in a power failure safe manner.</p>
	<p>Switching between the logbook-pages "+" previous page; "-" next page 1) Alternatively press the upper or lower areas of the list for switching pages. (Changeover only with a pushbutton pressure less than 1s, otherwise only long-text display without page switchover)</p>
	<p>Hold down < 1 sec. = Return to previous window Hold down > 1 sec. = Jump to window "Actual Process Value"</p>
	<p>Deletion of the logbook-entries</p>

5.4.4 Window: Program (Program controller graph)

This image shows the graphical representation of the selected control program.

	<p>The header displays the current program, the current step and the status. Right above the graph is the indication of the current program setpoint.</p> <p>On the right side, the zones are displayed, whose setpoints are specified by the program.</p> <p>At the bottom (x-axis) the time is shown in hours.</p> <p>The elapsed time is displayed as a blue ribbon. Here on the left below the 105. The current time is indicated by the thin blue line at the right end of the tape.</p>
	<p>These keys are used to control the program. Stop Pause and Start. If the program is stopped you will get to the menu for the program controller via the Edit button.</p> <p>If the total time of the program has expired (Stop displayed), the set-point of the last program step is retained.</p>
	<p>Hold down < 1 sec. = Return to previous window Hold down > 1 sec. = Jump to window "Actual Process Value"</p>

5.4.5 Window: Program controller Selection/Setting

This window gives an overview of the 8 control programs. One arrives on the Edit button in the "Program controller graph" into this menu.

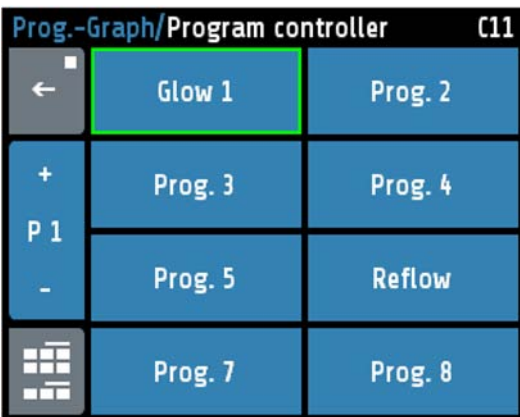
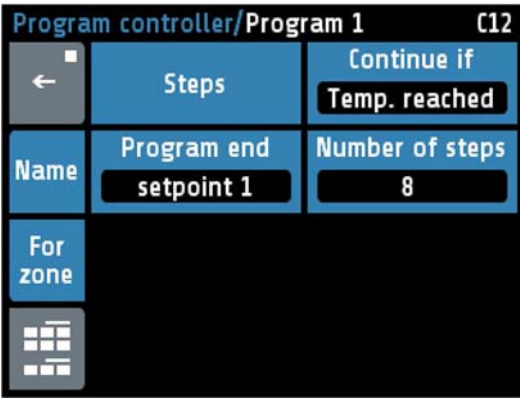
Select the program		
		<p>The green frame shows the selected program. Select a other program by pressing + and – keys.</p> <p>Press the respective program button branches to the setup menu of the program.</p> <p>The name of the program can be changed in the following window.</p>
Setting the program properties		
		<p>In this screen you can set the properties of the program. You can also use the "Steps" button to set the times and temperatures of the individual steps.</p> <p>The Name button is used to set the program name.</p> <p>Use the "For Zone" key to define the zones involved.</p>
Continue if	Time expired	All steps are executed according to the predefined time grid.
	Temp. reached	After the ramp time has elapsed, the current step temperature is controlled until all the relevant zones have reached this setpoint. * The setpoint must be reached up to + - 2K.
Program end	setpoint 1	After completion of the last step, the control setpoint is further regulated. Normally setpoint 1.
	Last setpoint	After the last step has been completed, the temperature of the last step is further regulated.
	Repeat	After the last step has been completed, step 1 is started again.
Number of steps	1 ... 8	Count of steps.

Step selection

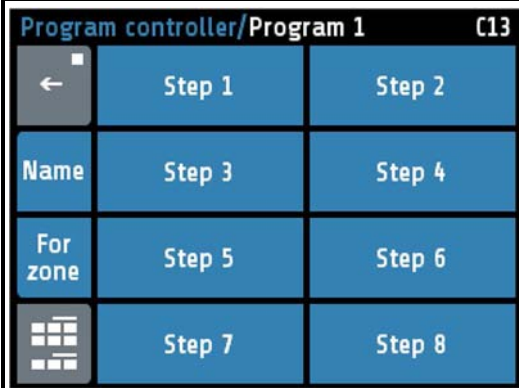

Here, the single step can be selected directly.

The name key is used to set the program name.

With the key "For Zone", the zones that will follow the program are defined.

Setting the program steps

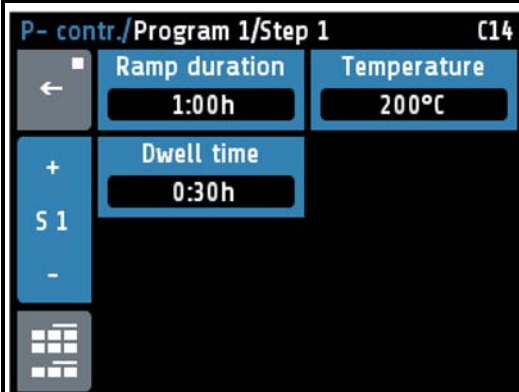

In this figure, the ramp duration, the step temperature and the dwell time can be set for one step.

The key S1 + leads to the next step.

The key S1 - leads to the previous step.

Ramp duration	0:00 ... 99:59h	Time setting in which the setpoint is to go up from the previous step temperature to the temperature of the current step. In the first step, the actual value is set as the start setpoint. * If no ramp is desired, set this time to 0: 00h.
Temperature	-100 ... 1600°C	Temperature for this step.
Dwell time	0:00 ... 99:59h	Time for the hold time of the current step temperature. The dwell time starts after the end of the ramp duration. When configuration is switched to "temp. reached", this time does not start until all the zones involved have the current step temperature. * Disabled zones are ignored. * For functional reasons, a "Dwell time" of at least one minute is used when the "Continue if" setting is set to "Temperature reached", even if the dwell time is set to "0:00h".

Headline Window: Actual Process Values „Home“



Headline of the screen: "Actual Process Values"

Program controller active, Step2 is running.

Top picture: Program running.

Bottom picture: Program paused or stopped.

5.4.5.1 Procedure of the program control:

The first step is to determine whether the program controller should run after a fixed time grid, or whether the respective step temperature must first be reached in order to reach the respective holding phase. (See parameter "Continue if")

You should also consider how the program controller should control the temperature after the end of the program. Three options are available: Setpoint 1, Last setpoint and Repeat. For more details, see "Program End".

The number of steps [1 ... 8] must also be defined.

Now the time and temperature values for the desired steps must be entered in the "Setting the program steps" screen.

One step always involves ramp duration and dwell time. The ramp duration determines the time in which the setpoint is steadily increased from the previous temperature to the temperature of the current step. The dwell time is the duration of the current step temperature.

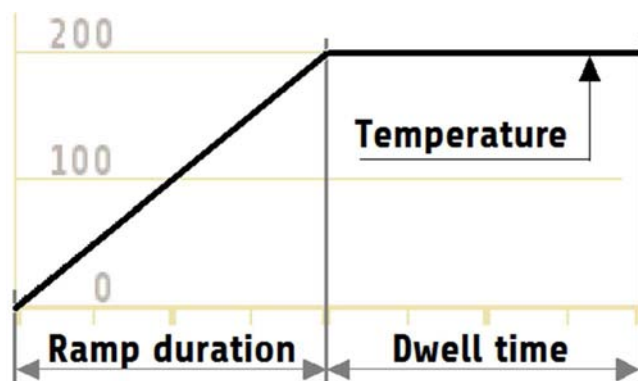

An exception is the ramp for the first step. Since the first step does not have a preliminary temperature, the ramp for all zones starts here with the current actual value of the first activated zone and ends at the temperature of step 1.





The ramp duration can be switched off by setting it to zero.

The dwell time is the duration of the current step temperature. If the parameter "Switch on" is set to "Temp. reached", the dwell time does not start until all zones have reached the step temperature.

After a network interruption with the program controller running, the program controller re-activates in the step at which the interruption took place.

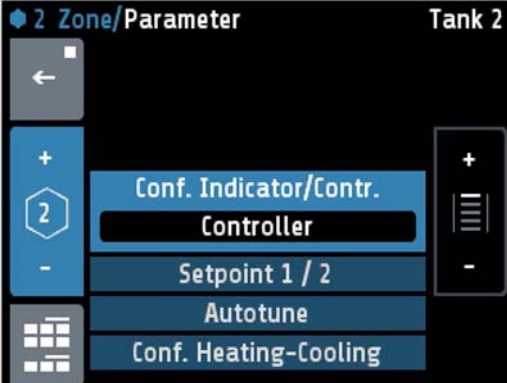
5.4.6 Window: Parameter

This window is used as a display and input of all zone-parameters for all zones.

	<p>The header displays on the left the zone number and the window name "Parameter". On the right the zone name "Tank 1" is shown.</p> <p>The selected parameter is displayed in the middle with light blue background. By pressing the +/- Buttons on the right (or pressing the upper or lower areas of the list) the list can slide up or down.</p> <p>Pressing the selected parameter will switch to a corresponding selection window.</p>
	<p>"+" switchover to the next zone. Display of the current zone number "-" switchover to the previous zone.</p>
	<p>Hold down < 1 sec. = Return to previous window Hold down > 1 sec. = Jump to window "Actual Process Value"</p>
	<p>Jump to window "Main"</p>

5.4.7 Zone – Parameter list

Conf. Indica- tor/Contr.	off	Measuring- or controlling zone switched off
	Controller	Controlling zone active <§>
	Indicator	Measuring zone active
If you switch to Controller or Indicator, a wizard is started to set the correct sensor and unit configuration.		

Setpoint 1 / 2		Setpoint 1 / Setpoint 2
Setpoint 1	Setpoint min ... Setpoint max	Setpoint 1 <§> = 0
Setpoint 2	OFF(Setpoint min) ... Setpoint max	Setpoint 2 <§> = OFF As soon as the logic input In_1 is on level 1, setpoint 2 will become active on all zones in which the adjusted value is unlike "Off".

Autotune	off	Switches off autotune <§>
	on	Activates autotune
	All zones	Starts self-optimization on all activated zones.
	Automatically	After a power restart auto-tuning starts automatically. If necessary after the soft start.

The tuning algorithm determines the characteristic values within the controlled process and calculates the valid feedback parameters (P, D, I) and the cycle time. (= 0.3 x D) of a PD/I- controller for a wide section of the range.

The autotune mode works during start-up shortly before the setpoint is reached. If activated after the setpoint has already been reached, the temperature will first drop by approx. 7% of the measuring range.

The tuning algorithm can be activated at any time by selecting the parameter **Autotune = "on"**. After having calculated the feedback parameters, the controller will lead the process value to the actual setpoint.

Selecting **Autotune = "off"** will stop the autotune function.

Autotune active: Indication in display "Zone synopsis" and "Actual process values" as an orange symbol: 

Autotune duration > 2 hours: autotune stops with an error message.

Conditions for starting the autotune algorithm:

- The setpoint must amount to at least 5% of the measurement range
- The sensor must not have a failure.
- The softstart function must not be active

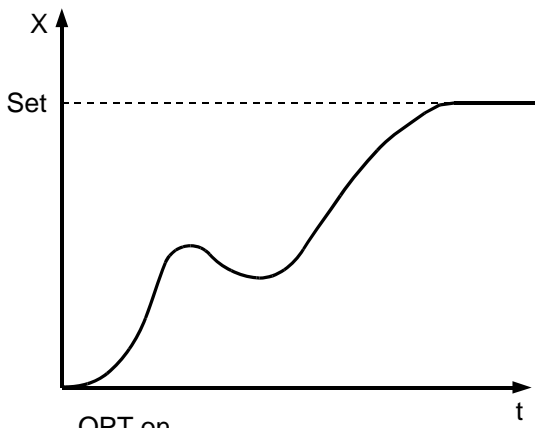

OPT on
self tune during start-up

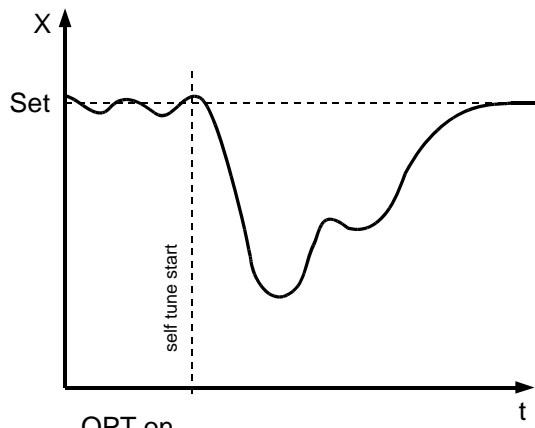

OPT on
self tune, after the setpoint has
already been reached

Configuration Heating-Cooling	Heating	Two-point controller: "Heating" <§>
	Cooling	Two-point controller: "Cooling"
	Non-lin. Cooling	Two-point controller: "Cooling", with non-linear characteristic curve for evaporation cooling
	Heating-Cooling	Three-point controller: "Heating-Off-Cooling"
	Heating - non-lin. Cool.	Three-point controller: "Heating-Off-Cooling", with non-linear characteristic curve for eva. cooling

Hints for adjusting the control parameters:

As standard the controller operates in PD/I control mode, i.e. controlling without deviation and with practically no overshoot during start-up.

The control action can be altered in its structure by adjusting the following parameters:

a. no control action (on-off)	Setting P = off Continuing with the parameter "switching difference"
b. P-action	Setting D and I = off
c. PD-action	Setting I = off
d. PI-action	Setting D = off
e. PD/I	Modified PID-mode (set: P,D,I)

Depending on the configuration, certain parameters are not visible.

5.4.7.1 Menu: Heating Control Parameter		
Only visible in operating modes heating or heating-cooling		
P (Xp)	OFF, 0.1 ... 400.0K	Proportional range <§=10,0> Unit: Kelvin
D (Tv)	OFF, 1 ... 200s	Derivative time <§=30s>
I (Tn)	OFF, 1 ... 1000s	Reset time <§=150>
Cycle-time	0.5 ... 240.0s	<§=10,0s> The switching frequency of the actuator can be determined through the cycle time. In this time interval the controller switches on and off once. <u>Voltage outputs for solid state relays (SSR):</u> Cycle time: 0,5...10 s Preferred settings for rapid control processes: 0,8s <u>Relay outputs:</u> Cycle time: > 10 s The cycle time should be adjusted to a time as long as possible in order to minimize wear of the relay contacts.
Max. Output ratio	0 .. 100%	<§=100%> The limitation of the output ratio is only necessary, if the heating energy supply is grossly oversized compared to the power required. Normally it should be switched off (Setting: 100 %). The limitation becomes effective when the controllers calculated output ratio is greater than the maximum permissible (limited) ratio. Warning! The output ratio limiting does not work during autotune.
Hysteresis	Only adjustable if "(xp)" = off (on-off action, without feedback)	
	OFF, 0.1 ... 80.0	For measuring range without decimal point <§=0.1>
	OFF, 0.01 ... 8.00	For measuring range with decimal point <§=0.01>

5.4.7.2 Menu: Cooling Control Parameter

Only visible in operating modes Cooling or Heating-Cooling

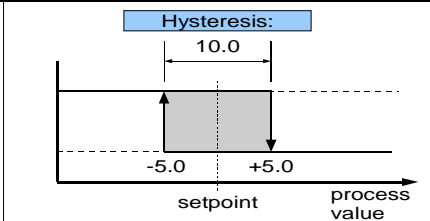
P (Xp)	OFF, 0.1 ... 400.0K	Proportional band <§=10,0> Unit: Kelvin
D (Tv)	OFF, 1 ... 200s	Rate time <§=30s>
I (Tn)	OFF, 1 ... 1000s	Reset time <§=150>
Cycle time	0.5 ... 240.0s	<p><§=10,0s> The switching frequency of the actuator can be determined by adjusting the cycle time. In this time interval the controller switches on and off once.</p> <p><u>Voltage outputs for solid state relays (SSR):</u> Cycle time: 0,5...10 s Optimal value for fast control loops: 0,8s <u>Relay-Outputs:</u> Cycle time: > 10 s In order to minimize the wear of the relay contacts the cycle time should be set as long as possible.</p>
Max. Output ratio	0 ... 100%	<p><§=100%> Limitation of the output ratio is only necessary, if the power supply of the control route is grossly overdimensioned. Normally it should be switched off (Setting: 100 %). Output ratio limiting interferes, if the calculated output ratio of the controller is higher than the max. output ratio that was set. Caution! Output ratio limiting does not work while auto-tune.</p>
Hysteresis	Only adjustable if "P (xp)" = off (on-off action, without feedback)	
	OFF, 0.1 ... 80.0	For measuring range without decimal point <§=0.1>
	OFF, 0.01 ... 8.00	For measuring range with decimal point <§=0.01>
		
Deadband	Switching point distance "heating" and "cooling" This parameter is available for "heating and cooling" operations only. (Configuration Heating-Cooling = Heating-Cooling)	
	OFF, 0.1 ... 80.0	For measuring range without decimal point <§=0.1>
	OFF, 0.01 ... 8.00	For measuring range with decimal point <§=0.01>

5.4.7.3 Ramps: Ramp rising / Ramp falling

A programmed ramp is always activated when the setpoint is changed or when the mains supply is switched on. The ramp starts at the actual process value and ends at the pre-selected setpoint. The ramp can be activated for both setpoint 1 and setpoint 2. By programming the second setpoint a setpoint profile can be obtained, accordingly (see example with external contact In_1 (K1) below).

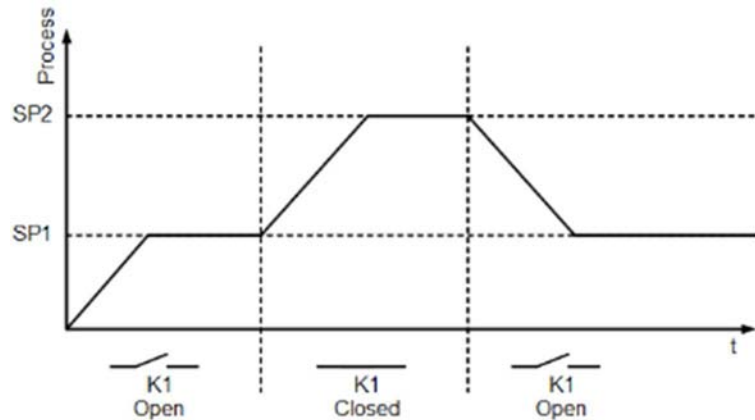

Ramp rising	OFF<§>, 0.1 ... 99,9	°K/min for measurement range without decimal point
	OFF<§>, 0.01 ... 9.99	°K/min for measurement range with decimal point

Ramp falling	OFF<§>, 0.1 ... 99,9	°K/min for measurement range without decimal point
	OFF<§>, 0.01 ... 9.99	°K/min for measurement range with decimal point

5.4.7.4 Menu: Softstart

Softstart-Funktion

For using the softstart function, make sure that the instrument is programmed to voltage (logic) outputs. This function is not allowed for relay outputs. Otherwise the relays will be damaged. During the softstart the controller's heating output response is limited to a pre-selected ratio, in order to achieve a slow drying of high performance heat cartridges. This results in a slower, more regular heating period.

Simultaneously the output clock frequency is quadrupled.

Once the process value reaches the softstart setpoint, it remains stable at this value for the preselected duration time. At the end of this period the process value rises to the valid setpoint. If the softstart is active, the controller's autotune function cannot operate.

If a setpoint ramp has been programmed, the softstart has priority, and the ramp will become active after the softstart has been completed.

The softstart only works:

- if the parameter P (xp) is programmed > 0,1%
- if the actual process value is lower than the softstart setpoint – 5% of the selected measuring range

It is possible to select this function for each zone individually.

Softstart On/Off	Off	Softstart function not active. <§> The remaining softstart parameters are not displayed.
	On	Softstart function is active.

Softstart Output ratio	10 ... 100%	<§ = 30>
-------------------------------	--------------------	-----------------------

Softstart setpoint	Range: Setpoint min...setpoint max.	<§ = 100°C>
---------------------------	--	--------------------------

Duration time	Off, 0.1 ... 10.0 min	<§ = 2.0 min>
----------------------	------------------------------	----------------------------

Output mode	Controller mode	Controller mode
	Mode AUTOM.	<p>In the event of sensor break the last valid output ratio is maintained.</p> <p>Like the setpoint, the output ratio can be changed manually.</p> <p>Under the following circumstances, the output ratio will be 0%:</p> <ul style="list-style-type: none"> - if the output ratio was at the time of sensor break 100% - if the controller is working along a setpoint-ramp - if the control deviation from the measuring range was at time of sensor break > 0,25% - if parameter is set P (xp) = 0 - if softstart was active at the time of sensor break. <p>A few seconds after sensor break has been rectified, the controller returns to automatic operation and calculates the required output ratio.</p>
	Mode MANUAL	<p>The controller now operates as an actuator only. The control function is inactive</p> <p>Process display: Actual process value. Setpoint display: Display of current output ratio in %. The output ratio can be changed manually.</p>

5.4.7.5 Menu: Limit values		Adjustment of the limit values. It is necessary to set the limit configuration first. See: 5.4.8.2
Limit 1 min.	OFF(MRS) ... MRE	For absolute limits <§> = OFF
	-100 ... OFF(0)	For relative limits
Limit 1 max.	OFF(MRS) ... MRE	For absolute limits <§> = OFF
	OFF(0) ... 100	For relative limits
Limit 2 min.	OFF(MRS) ... MRE	For absolute limits <§> = OFF
	-100 ... OFF(0)	For relative limits
Limit 2 max.	OFF(MRS) ... MRE	For absolute limits <§> = OFF
	OFF(0) ... 100	For relative limits
Configuration limits 1	Jump into sub menu „Configuration limits 1“. See 5.4.8.2	
Configuration limits 2	Jump into sub menu „Configuration limits 2“. See 5.4.8.2 Fehler! Verweisquelle konnte nicht gefunden werden.	
Undercurrent val.	OFF(0) ... 99,9	<§> = OFF
Overcurrent val.	OFF(0) ... 99,9	<§> = OFF

5.4.7.6 Menu: Sensor settings		All parameters for sensor configuration
Sensor		Description see 0 Configuration sensors
Process offset	-999..0..1000°C	<§= 0°C> This parameter serves to correct the input signal: - the correction of a gradient between the measuring point and the sensor tip - line resistance balancing at 2-wire-RTD - Correction of the control deviation when using P or PD action. If for example the offset value is set to +5°C, then the real temperature measured by the sensor is 5°C less than the displayed actual process value. Make sure that the adjusted actual temperature value should not fall below or exceed the measuring range limits.
Setpoint min.	MR-Start ... Setpoint max.	Lowest adjustable setpoint value. <§ = 0> MR-Start: Start of measurement range
Setpoint max.	Setpoint min ... MR-End	Highest adjustable setpoint value. <§= 400> MR-End: End of measurement range
The minimal span of linear value min. and max. is 100, the maximal span is 2000.		
Linear value min. For linear measurement range only	-900 ... (Linear value max. -100)	Measuring range starting value of the linear scale. <§= 0,0>
Linear value max. For linear measurement range only	(Linear value min. +100) ... 10.000	Measuring range final value of the linear scale. <§= 100,0>
Decimal For linear measurement range only	0 ... 2	Decimal of the linear measuring range. <§= 1>
Unit zone	°C ... °F	For control zones, you can choose between ° C and ° F. <§=°C> The temperature values of the selected zone are set to the specified unit with this parameter. Please check all temperature values after adjustment. (Limit values, setpoints, setpoint limits, actual value offset and, if applicable, the linear limits.)
	°C, °F, OFF, %, A, V, Hz, rpm, U/min, bar, psi, Pa, l/min, m ³ , l, m/s, m ² /s,	Numerous units can be set in display zones. <§=OFF> No unit = OFF

	kg, N, Nm, J, J/m ³ , s, min, h	
--	---	--

5.4.7.7 Control outputs

Possible settings for the logic outputs and relay or continuous outputs.

This is used to determine which signal is sent to the output.

¹⁾ The settings for heating and cooling are only visible if the controller is configured accordingly.

Conf. digital out	off	No function
	Heating ¹⁾	Output of the heating signal at digital output x. <§>
	Cooling ¹⁾	Output of the cooling signal at digital output x.
	Limit 1	Output of limit violation 1 to digital output x.
	Limit 2	Output of limit violation 2 to digital output x.

When using the relay as the actuating output, the switching cycle time must be set as long as possible in order to minimize the contact wear of the relay.

Conf. relay out	off	No function
	Heating ¹⁾	Output of the heating signal at relay x. <§>
	Cooling ¹⁾	Output of the cooling signal at relay x.
	Limit 1	Output of limit violation 1 to relay x.
	Limit 2	Output of limit violation 2 to relay x.

Continuous out configuration (Option)	off	No function
	Heating ¹⁾ output ratio	Output of the heating output ratio at continuous output x <§> (0..20mA or 0..10V)
	Cooling ¹⁾ Output ratio	Output of the cooling output ratio at continuous output x (0..20mA or 0..10V)
	Current value	Output of the current value to the continuous output x (0..20mA or 0..10V)
	Heating out- put ratio live zero ¹⁾	Output of the heating output ratio at continuous output x with offset zero. (4..20mA or 2..10V)
	Cooling out- put ratio live zero ¹⁾	Output of the heating output ratio at continuous output x with offset zero. (4..20mA or 2..10V)
	Current value live zero	Output of the current value to the continuous output x with offset zero. (4..20mA or 2..10V)

The minimal span of Continuous out min. and max. is 10.

Cont. out min. For "continuous out configuration" = "Current value" only	MR-Start ... (Cont. out max. -10)	Starting value of the linear output. <§= 0> Corresponds to 0/4mA or 0/2V.
---	--	---

Cont. out max. For "continuous out configuration" = "Current value" only	(Cont. out min. +10) ... MR-End	Final value of the linear output. <§= 800> Corresponds to 20mA or 10V.
---	--	--

Copy all parameters	to zone	Transfer all zone parameters to another zone
Opens a window for selecting the zones into which the parameter values of the current zone shall be copied. (Not available for 1 zone controller)		

Zone name	Opens the "Setting text" window to enter a name for the actual zone. This name is shown in the home screen for controllers with 6 zones and less.
------------------	---

5.4.8 Window: Tools

	<p>Pressing the configuration key leads to windows in which the associated parameters can be selected or set.</p> <p>Pressing the wizard key activates a guided setting help for the most important device parameters.</p>
	<p>Hold down < 1 sec. = Return to previous window Hold down > 1 sec. = Jump to window "Actual Process Value"</p>
	<p>Jump to window "Main"</p>

5.4.8.1 Configuration Monitoring 1+2

Settings for messages of monitoring 1. The same applies to monitoring (2).		
The controller has two independent monitoring relays. With the help of the monitoring several events of the controller can be routed (wired OR) to the relays.		
If the monitoring is active it is displayed by the bell symbols (). The colour of the symbols is programmable for the limit violations and fixed for all other events. In case of several events with different colours at the same time the priority of the colours is: red, orange, green.		
Limit 1	---	Not selected <§ for Monitoring2>
	One zone => Message	Once Limit 1 is active in one zone, monitoring 1(2) is set. <§ for Monitoring1>
	All zones => Message	Monitoring 1(2) is not set until Limit 1 is active in all zones.
Limit 2	---	Not selected <§ for Monitoring1>
	One zone => Message	Once Limit 2 is active in one zone, monitoring 1(2) is set. <§ for Monitoring2>
	All zones => Message	Monitoring 1(2) is not set until Limit 2 is active in all zones.
Sensor error Colour: red	---	Not selected <§ for Monitoring2>
	Active	In the case of sensor break monitoring 1(2) is set. <§ for Monitoring1>
Restart lock-out Colour: orange	---	Not selected <§>
	generate Signal	Monitoring 1(2) is set, if a restarting-incident triggered.
System error Colour: red	---	Not selected <§>
	Active	Monitoring 1(2) is set, if system error occurred.

End of Program controller Colour: orange	---	Not selected <§>
	generate Signal	Monitoring 1(2) is set, when the program controller has finished.
Moni 1(2) Relay	Direct	Relay switches on, if monitoring 1(2) is active. <§>
	Indirect	Relay switches off, if monitoring 1(2) is active.
Current alarm Colour: red	---	Not selected <§ for Monitoring1>
	Active	Monitoring 1(2) is set, if current alarm occurred. <§ for Monitoring2>

5.4.8.2 Configuration Limit 1+2

Settings for limit values min./max. and configuration of limit monitoring 1/2		
<p>The controller features two independent limit monitors. From firmware version V36/20, the limit value monitoring can be configured zone by zone.</p> <p>These limit values can be output to the monitoring relays via the monitoring function (5.4.8.1). Irrespective of this, the limit value overruns can be output on the zone relays or logic outputs.</p> <p>With a programmed setpoint ramp, the relative limit values are tracked to the current ramp setpoints. In the case of sensor and line errors, the limit value violations react in the same way as range override.</p>		
Desired function	Setpoint based limit alarm	Absolute limit alarm
<p>Limit exceeded.</p> <p>The actual value must be greater than the sum of the max. and setpoint or as the absolute limit for the limit monitor to become active.</p>		
<p>Falling below the limit.</p> <p>The actual value must be smaller than the difference of (setpoint – limit min.) or smaller than the absolute limit min., so that the limit value monitoring becomes active.</p>		
<p>Double-sided limit monitoring.</p> <p>The actual value must be outside the range for the limit value monitoring to become active.</p>		
Limit values	Limit value 1 / 2 (min.)	Relative to setpoint: -200...0;OFF (+1 \triangleq OFF<§>) Absolute: MB-Start<§> ... MB-End
	Limit value 1 / 2 (max.)	Relative to setpoint: OFF;0...200 (-1 \triangleq OFF<§>) Absolute: MB-Start<§> ... MB-End
Type limit	Absolute	Absolute limits. Not dependent on setpoint. <§>
	Based on setpoint	Limits relative to setpoint.

Delay	OFF	⏸ -Alarm delay switched off. <§>
	1 ... 8000 s	⏸ -Alarm is delayed by selected time.
Self-retaining	off	No self-holding of the temperature alarm. <§>
	on	An activation of the ⏸ -alarm will be stored. The ⏸ -alarm can be acknowledged in the window "Monitoring".
Start suppression	OFF Without start up	Start-up ⏸ -alarm suppression switched off <§>
	Start up Suppression active	Start-up ⏸ -alarm suppression active: Temperature must be within the limits once. Only then the ⏸ -alarm is activated when reaching the alarm value.
Display colour	Red	The monitoring displays the ⏸ -alarm in red colour. <§>
	Green	Intended for enabling signals: Display colour is green.
	Orange	
Switching behaviour	Direct	The monitoring output is activated when the max. limit value has been exceeded or if the min. limit value has been undercut.
	Inverse	The signal is inverted and output to the monitoring. If the min. limit value has been exceeded or if the max. limit value has been undercut the output is set.

5.4.8.3 Wizard

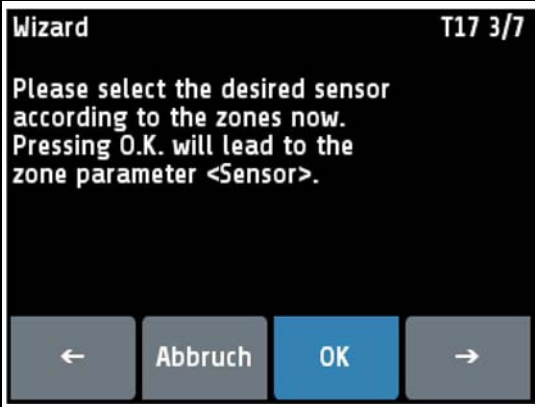
	<p>The wizard serves as a support for initial commissioning of the controller or in the occasion of a reconfiguration.</p> <p>Please notice the wise order in which the parameters of the wizard have to be adjusted. The wizard can be cancelled at any time. By pressing the arrow keys you will move on to the next step. Pressing the OK-key will lead to the parameters.</p>
---	---

New controllers automatically start with the wizard. After pressing "finish" in the last window of the wizard the wizard will not be shown anymore at startup.

Window: System

5.4.8.4 Field Bus / USB / LAN

Menu: Fieldbus		It depends on the installed field bus module what parameters will be visible.		
Protocol	off	No protocol selected		
	Elotech	<SERIAL> ELOTECH-Standard-protocol		
	Modbus	<SERIAL> Modbus-RTU-protocol		
	Arburg 1	<SERIAL> Hot runner: One device address for all zones.		
	Arburg 2	<SERIAL> Hot runner: Every zone has its own address.		
	Arburg 3	<SERIAL> Protocol for temperature control systems		
	Profibus DP	<PROFIBUS> Profibus DP		
Status				
Display only	---	<SERIAL> No data communication		
	Data Exchange	<SERIAL> Data communication is active <PROFIBUS> Data-Exchange-Mode		
	Wait Param	<PROFIBUS> Controller waits for configuration / parametrisation		
	No connection	<PROFIBUS> No master connected / Master not active		
Baudrate				
<SERIAL>	1.2 kBaud	1.200 Bit/s	9.6 kBaud	9.600 Bit/s <§>
	2.4 kBaud	2.400 Bit/s	19.2 kBaud	19.200 Bit/s
	4.8 kBaud	4.800 Bit/s	38.4 kBaud	38.400 Bit/s
Baudrate <PROFIBUS>	Display only	45,5 kBaud – 12Mbaud (forced by the master) Not detected = no master connected		
Address				
	1 ... 255	1<§> ... 255 (ELOTECH-Standard) 1<§> ... 247 (Modbus-RTU-Protocol) 1<§> ... 32 (Arburg-Protocols) 2<§> ... 125 (Profibus) At this address a master communicates with the controller. Each controller needs a unique address.		
Format				
<SERIAL>	7 E 1	7 Data bits, 1 Stop bit, Parity Even <§>		
	7 O 1	7 Data bits, 1 Stop bit, Parity Odd		
	7 E 2	7 Data bits, 2 Stop bits, Parity Even		
	7 O 2	7 Data bits, 2 Stop bits, Parity Odd		
	7 N 2	7 Data bits, 2 Stop bits, Parity None		
	8 E 1	8 Data bits, 1 Stop bit, Parity Even		
	8 O 1	8 Data bits, 1 Stop bit, Parity Odd		
	8 N 1	8 Data bits, 1 Stop bit, Parity None		
	8 N 2	8 Data bits, 2 Stop bits, Parity None		
HW-config				
<SERIAL>	The serial fieldbus module has three integrated interfaces. Select here the desired interface:			
	RS232/RS485	Signals see connection diagram.		
	TTY	Signals see connection diagram.		
Remote				
<PROFIBUS>	On	Profibus can read and write. Local operation is locked.		
	Off	Profibus can read only. Local operation is permitted. <§>		
Sensor selection				
<PROFIBUS>	Internal	The actual value is generated via the internal sensor. <§>		
	via profibus	The actual value is specified via the Profibus interface.		



Menu: USB		Save controller data on an USB-Stick. (USB-flash drive) The data is stored as a text file in an adjustable CSV-format. The USB-flash-drive must be formatted with FAT. (FAT16/ FAT32) The file name contains the last 5 digits "xxxxx" of the MAC-ID.
Save to USB	All parameters	Save all parameters for all zones. Generates the file -> LogParaxxxxx.txt and LogPara.bin
	Al. Logbook	Save the entries of the Alarm Logbook. Generates the file -> LogBookxxxxx.txt
	Graph	Save the measuring points of the graph for all zones. Generates the file -> LogGraphxxxxx.txt
	Act. program	Save the current program of the program controller. Generates the file -> ProgAkt.bin
	All programs	Save all programs of the program controller in one file. Generates the file -> ProgAll.bin
USB status		
	- - -	Display of the USB-status: no stick detected.
	Key detected	USB-stick detected: Files can be saved or loaded from the USB flash drive.
Load		
	Load all Parameters	Loading a previously saved parameter set. The file "LogPara.bin" must exist on the USB flash drive.
	Act. program	Load a program for the program controller. The program con- tained in the ProgAkt.bin file is loaded into the currently set program.
	All programs	Load all programs. The programs contained in the ProgAll.bin file are loaded into the program controller.
Separator		
	none <§>	Delimiter symbol between single data sets: Spaces
	comma	,
	semicolon	;
	colon	:
	tabulator	<TAB>
Sample-Interval		
	OFF; <§> 5...720s	Cycle time for writing an output line with time stamp on the USB stick.
<p>If the parameter "Log interval" is set to a numerical value, so a file named "LogR4000_xxxxx_YYYY_MM_DD.txt" is generated on the USB stick. "xxxxx" the last 5 dig- its of the MAC-ID. YYYY, MM and DD mean the year, month, day. After a change of date a new file is created.</p> <p>With the included names MAC-ID "xxxxx", the files can be assigned to different R4000 con- trollers.</p> <p>Each "Log interval" time a new row is added. The line includes a time-stamp, setpoint, the actual value, the output ratio and the actual current value of Zone 1 to Zone 8.</p>		

Menu: LAN		Ethernet interface for connection to the configuration tool Elo-Vision 3 or for a MODBUS-TCP communication.
IP-address 1		IP-Address 192 . 168 . 100 . 100 Part 1 <§>
IP-address 2		IP-Address 192 . 168 . 100 . 100 Part 2
IP-address 3		IP-Address 192 . 168 . 100 . 100 Part 3
IP-address 4		IP-Address 192 . 168 . 100 . 100 Part 4
Subnet mask		
Subnet mask 1		Subnet mask 255 . 255 . 255 . 0 Part 1 <§>
Subnet mask 2		Subnet mask 255 . 255 . 255 . 0 Part 2 <§>
Subnet mask 3		Subnet mask 255 . 255 . 255 . 0 Part 3 <§>
Subnet mask 4		Subnet mask 255 . 255 . 255 . 0 Part 4 <§>
Default gateway		
def.-gateway 1		Default gateway 192 . 168 . 100 . 1 Part 1 <§>
def.-gateway 2		Default gateway 192 . 168 . 100 . 1 Part 2 <§>
def.-gateway 3		Default gateway 192 . 168 . 100 . 1 Part 3 <§>
def.-gateway 4		Default gateway 192 . 168 . 100 . 1 Part 4 <§>
MAC ID	549A11:5xxxxx	Display of the MAC-ID: 54:9A:11:5x:xx:xx

5.4.8.5 Configuration Current alarm (option)

<p>The heater current monitoring function is valid for all connected zones. Only zones with logic output for the heating signal will take part in current monitoring. Ensure that the limit value is set correctly to avoid false alarms in case of supply voltage changes. The alarm can be delayed by selecting a delay time to avoid false alarms caused by single disturbances. The heater current measuring is designed for a current transformer 1:1000. (Accessory type: M2000 1:1000 max. 60A) When using other transformers the ratio can be modified.</p>		
Current alarm limits / Undercurrent alarm value	OFF, 0.1 ... 99.9 A	Zone parameter: Absolute value <§=OFF> Currents below this value will cause an alarm.
Current alarm limits / Overcurrent alarm value	OFF, 0.1 ... 99.9 A	Zone parameter: Absolute value <§=OFF> Currents above this value will cause an alarm.
Leakage limit Monitoring an impermissible continuous current	Limit value: OFF, 0,0...99,9 A <§>=0,3A	SSRs (especially if they are combined with RC-combinations) normally have small leakage currents. These currents add up and the sum can lead to a permanent leakage current. A leakage current limit value is programmable. All values below this limit will not be considered in the alarm monitoring. The field "act. Leakage current" displays the leakage current that has just been measured. If a permanent current (SSR short circuit) is detected the alarm will be activated. The zone with a permanent current can be detected by observing the actual process values (proves value too high).
act. Leakage curr.	Display of the actual leakage current	
Current transformer Turns ratio	1:100 ... 1:9999	<§ = 1:1000 for M2000>
Cycle time	1...60s	Time interval between the current measurements of two successive zones. <§ = 2s>
Delay	Settings in 5 steps, unit: seconds The values depend on the cycle time and the number of active controller zones. Off = no delay time active <§=off>	

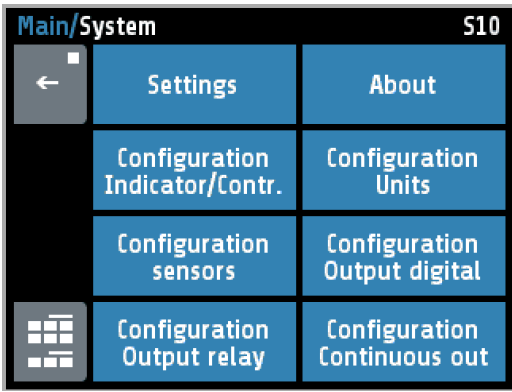
5.4.9 Window: System

		<p>Pressing the configuration key leads to windows in which the associated parameters can be selected or set.</p> <p>Pressing the key "About", shows hardware information of the controller.</p> <p>The continuous outputs menu appears only for controllers with the option "continuous". The relay outputs are lost in this case.</p>
	<p>Hold down < 1 sec. = Return to previous window Hold down > 1 sec. = Jump to window "Actual process value"</p>	
	<p>Jump to "Main"</p>	

5.4.9.1 Settings

Language	Deutsch (German)	German <§>
	English (English)	English
Device name		
Alphanumerically adjustable name for the controller. The name is displayed in the header of the basic screen and is used to generate log file names. <§ = empty, no text>		
Authorisation (LOC)	All Parameter adjustable	All parameters adjustable <§>
	Setp. and ramps adjustable	Setpoint values, alarm values and ramps are adjustable. All other parameters are locked.
	Only setpoints adjustable	All other parameters are locked
	Setp. and clock adjustable	Setpoint values are adjustable and time/date is adjustable. All other parameters are locked.
	All parameters locked	No parameter is adjustable
	Change Lock code	Here the code (start value = 0000) can be changed to a different value.
The old code is requested before the setting of the new code. The new Code has to be entered twice. The parameters that have been locked can be displayed but not changed. This parameter cannot be changed if the logic input In_2 is active, or the lock code is not known. The value of the factory setting is <§ = 0000>		
Clock, Time, Date		
Time	Hours	Number value 0 ... 23
	Minutes	Number value 0 ... 59
Day / Month	Day	Number value 1 ... 31
	Month	Number value 1 ... 12
Year	2000 ... 2150	Adjustment of calendar year
Sample rate	Time interval between the current measurements of two successive zones. In brackets the complete time interval as shown on display:	
Scanning time for recorder function	2,5 s (Total time: 8,2 Min) 5 s (Total time: 16,5 Min) 10 s (Total time: 33 Min) <§> 30 s (Total time: 99 Min) 1 Min. (Total time: 3,3 h) 5 Min. (Total time: 16,5 h) 10 Min.(Total time: 33 h)	
A maximum of 198 temperature points can be saved.		
Even heatup	Off	Compound heating switched off <§>
	Active	Compound heating is switched on. The switched-on zones are heated up in a network. This makes sense for controlled systems of different speeds, the temperatures of which should not differ greatly from one another. Faster zones are aimed at the slower zones.

Zone offset	OFF	<§>
	1 ... 91	The adjusted offset value is added to the displayed zone numbers in the windows. Therefore a continuous numbering of the zones can be achieved if more than one device is used. Examples: Offset= OFF: Zone numbering: 1-8 Offset= 4: Zone numbering: 5-12
Zone numbers	Visible only when zone offset is off.	
Zone 1...8	OFF; 1...99	<§> OFF With this parameters, individual numbers can be assigned to the zones. In all windows these values are displayed, instead of the real zones.
Restart lock-out	OFF	No function <§>
	On	After power-on all zones are switched off and a message is displayed. Switch on must be acknowledged. After acknowledgement all zones, that were on before the power fail, will be switched on again. In addition the alarm "Restart lock-out" will be set and can be handled in the monitoring.

5.4.9.2 About / → Firmware update

Firmware	Displays the current firmware and language version.
Firmware update	<p>Start the firmware update by selecting the button "Start Update" and confirm with SAVE. A confirmation prompt opens. If this window is confirmed with YES, the unit turns into the loader mode.</p> <p>When the loader mode is accidentally turned on, you can switch back by a mains reset into the existing user program.</p> <p>If an update should be performed, a USB flash drive must be plugged in with the new firmware. After a short time the firmware folder appears in the line "Folder". E.g. „EL4000.01_V20xx_xx.ELO".</p> <p>Now you can start the loading process by touching the touch screen. The controller must not be disconnected from the power supply until the download is complete! After finished loading the new user program is started by a power interruption.</p>
Type R4000-0-x-x-000-0x-5	Type key of the controller
Factory setting	Reset to factory delivery status. With the help of this parameter, all settings are deleted and reset to the delivery status. Choose "Reset", then press "SAVE".

Type R4010-0-x-0-000-00-5	Only with zone extension 12 or 16. Type code of the additional module.
Zone extension	(Only available for the 8-zone version) off <S> 12: Extended to 12-zone controller. Requires additional module R4010-04 16: Extended to 16-zone controller. Requires additional module R4010-08

5.4.9.3 Configuration Indicator/Controller

For each zone you can choose here whether you want to serve as a pure indicator zone or as a control zone. Also, the zone can be switched off.



Conf. Indicator/Contr. Zone 1 ... x	Description see 0 Zone – Parameter list Conf. Indicator/Contr. at page 23
--	---

5.4.9.4 Configuration Units

For each zone, the unit to be displayed can be selected here. In case of control zones, the unit can be °C or °F, for indicator zones, additional unit (OFF),%, A, V, Hz, rpm, rpm, bar, psi, Pa, l/min, m³, l, m/s, m²/s, kg, N, Nm, J, J/m³, s, min or h can be selected.

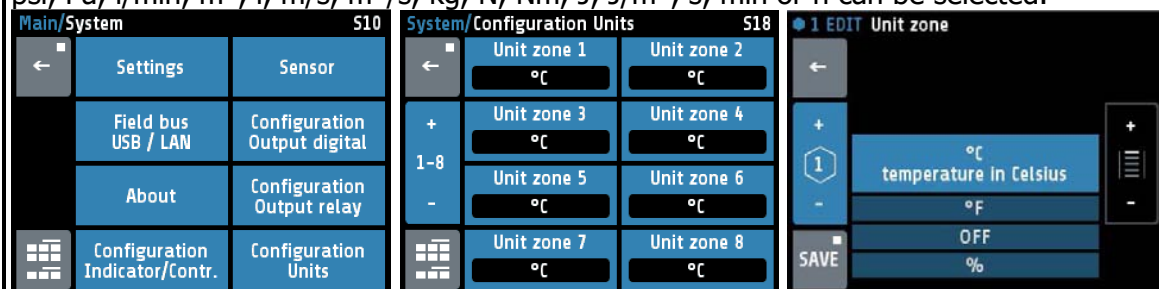

Unit zone	Description see at 5.4.7.6 Menu: Sensor settings Unit zone
------------------	---

5.4.9.5 Configuration sensors

Sensor	Linear 0...10 V	Voltage 0 to 10 V
	Linear 0...20 mA	Current 0...20mA
	Linear 4...20 mA	Current Live Zero 4...20mA
	PT100 2-wire	Pt 100 (RTD) 2-wire connection -100...800°C
	PT100 3-wire	Pt 100 (RTD) 3-wire connection -100...800°C
	Ni120 2-wire	Nickel 120 2-wire connection 0...250°C
	Ni120 3-wire	Nickel 120 3-wire connection 0...250°C
	(TC) Fe-CuNi (J)	Thermocouple Type J 0...800°C
	(TC) NiCr-Ni (K)	Thermocouple Type K 0...1200°C
	(TC) Fe-CuNi (L)	Thermocouple Type L 0...800°C
	NiCrSi-NiSi (N)	Thermocouple Type N 0...1200°C
	(TC) PtRh-Pt (S)	Thermocouple Type S 0...1600°C
Please NOTE :		
If the sensor selection is changed and the value is out of the new measuring range, the following parameters will be reset.		
	Setpoint 1, Setpoint 2:	Setpoint limitation min.
	Setpoint min.:	Measuring range bottom
	Setpoint max:	Measuring range top
	Setpoint ramp rising/falling:	off
	Limit values:	off
	Actual process value offset:	off
	Setpoint softstart:	setpoint min.
	softstart:	off

5.4.9.6 Configuration Output digital

A digital output (logic output) is available for each zone. Select the desired output signal. Configurations that are not possible are not displayed. Like "cooling" in this example.

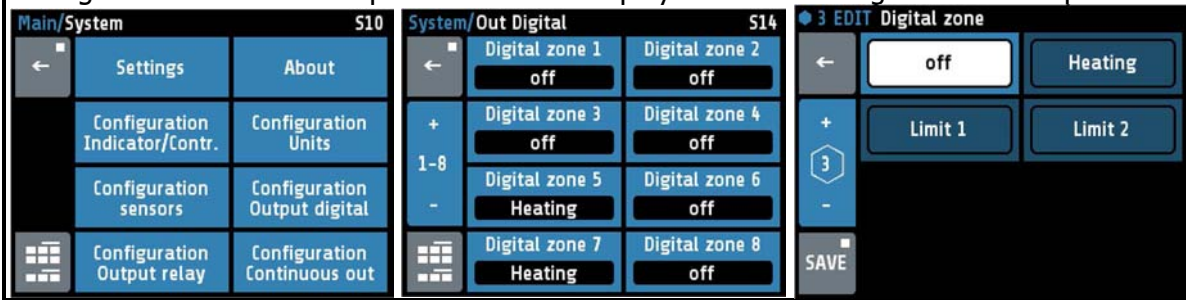

Digital 1 ... x | Description see 5.4.7.7 Control outputs

5.4.9.7 Configuration Output relay

For every zone one relay output is available. Select the desired output signal. When using it as a control output, make sure that the switching cycle time is set as long as possible to minimize contact wear on the relay. Configurations that are not possible are hidden. In the example, heating and cooling can be selected because the zone has been configured as a "heating-cooling" zone. (3-point heating cooling)



Relays 1 ... x | Description see 5.4.7.7 Control outputs

5.4.9.8 Configuration of continuous outputs (option)

A continuous output is available for each zone. Select here the desired output signal. Configurations that are not possible are hidden, such as "Cooling output level" and "Cooling output level". Live Zero ", in the picture below.

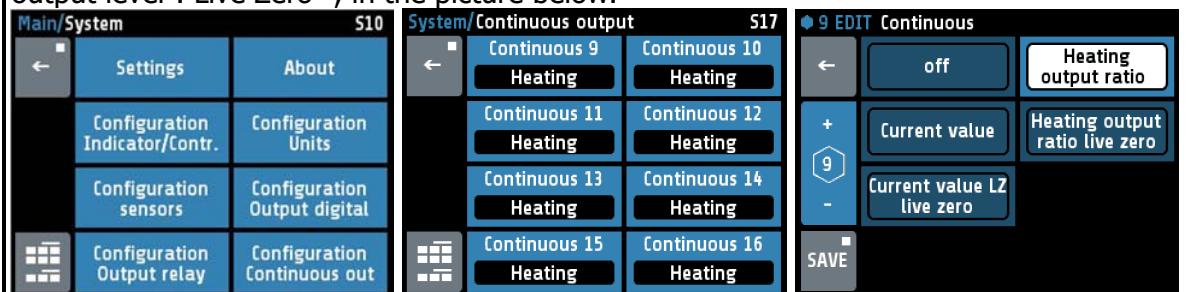

Continuous 1 ... x | Description see 5.4.7.7 Control outputs

6 Error Messages

Error message	Cause	Possible remedy
At actual process value maximum value flashes	Top range end has been exceeded, sensor defect	Check sensor and cable
At actual process value minimum value flashes	Bottom range end has been exceeded, sensor defect	Check sensor cable Check process value offset TC connected with inverted polarity
REMOTE: Parameter locked	Adjusting of parameters is not allowed. Device is controlled by fieldbus.	Profibus: The parameter "Remote" in the menu Field bus is set to "on".
EloVision is active!	Adjusting of parameters is not allowed. Device is controlled by EloVision.	The configuration-tool EloVision is active. Please close EloVision, or switch to the visualisation page of von EloVision.
Field bus module unavailable		The controller is not fitted with the correct hardware for the selected protocol.
Zone synopsis: Current: --.-A	No current measurement	Set the logic output of the corresponding zone to heating.
DfErr	Text display error	Please send the controller back to the manufacturer.
ERR0	System error	Please send the controller back to the manufacturer.
ERR8	System error	Quit error message. Check the parameters. If the error is still there, send the controller back to the manufacturer.
ERR IO	Error I/O board See logbook: Error IO board 1 or 2 Error IO board 3 or 4	The connection to the input/output circuit board is broken. -> Internal card defective, please send the controller back to the manufacturer. -> If zone extension (5.4.9.2 menu About) is set to 12 or 16, the required additional module R4010 may not be connected. Switch off zone extension if necessary. <i>Info: All 4 sensors of the faulty card are set to sensor break.</i>

7 Technical Data

Input Pt100 (DIN)	2- or 3- wire connection possible Built-in protection against sensor breakage and short circuit Sensor current: ... < 1 mA Accuracy: ... < 0,2 % Linear error: ... < 0,2 % Influence of the ambient temperature: ... < 0,01 % / K
Input Thermocouple	Built-in internal compensation point and protection against sensor breakage and incorrect polarity. Accuracy: ... < 0,25 % Linear error: ... < 0,2 % Cold junction error: 0,5K Influence of the ambient temperature: ... < 0,01 % /
Input voltage 0...10V	Internal resistance > 100 k-Ohm Accuracy: < 0,25 % Linearity error: < 0,2 % Ambient temperature influence: < 0,01 % / K
Input current 0...20mA	Internal resistance < 100 Ohm Accuracy: < 0,25 % Linearity error: < 0,2 % Ambient temperature influence: < 0,01 % / K ! The input has high impedance when the controller is without supply voltage.
Logic input	Internal resistance > 22k-Ohm Level 0 < 2V Level 1 > 9V; max 30V
Heater current monitoring	Measuring input range: 0... 100mA corresponding 0,0...99,9A when using a current transformer 1: 1000. If the range is exceeded, the controller may be damaged.
Logic outputs	Bist. voltage, 0/24 V DC, max. 500 mA, short-circuit proof
Relay outputs/ Alarm outputs	Relay; max. 250V AC, max. 2A, resistive load
Continuous outputs	0...20 mA maximal load 300 Ohm; 0...10V minimal Load 5kOhm. Automatic switching, depending on connected load.
Fieldbus Interface:	Depends on the version of the device: - Serial: RS232, RS485, TTY (20mA) - Profibus DP, according to EN 50170 All with optical isolation.
Service-Interface	Ethernet: Modbus TCP
USB-Interface	Host for USB-Stick; max. 100mA
Supply voltage	24 V DC, +/-25 %, appr. 6W + Power of logic outputs
LCD-Display	8,8 cm (3,5") RGB-display with LED-backlight. 320 x 240 pixel with resistive Touch-Panel
Data protection	EAROM, Semiconductor storage When using a Fieldbus interface please note: Permissible writing operations per parameter must not exceed 1 000 000.

Casing	Format, case: 96x96mm, acc. DIN 43700, Installation depth 122 mm Panel cut-out: Width=92 +0,5 mm x Height=90 +0,5 mm Material: Sheet steel and Makrolon UL 94-V1 Protection mode: IP 20 (DIN 40050), Front side: IP 50
Connectors	Service-Interface: Ethernet RJ45 USB-Interface: Type A Profibus: SUB-D 9 Others: spring-loaded push terminals, Protection mode IP 20 (DIN 40050), Insulation class C Cross-sections: Terminal groups: A, B, D, E, F, G, I, K, M, N, Q + C, H (continuous) = 1,5 mm ² (for end sleeves with plastic collar 0,75mm ²) Terminal groups: C, H, (Relay), P = 2,5mm ²
Real time clock	Backup battery: Lithium CR2032
Weight	Approx. 800g, depends on the version of the device
E-Bus	Bus system for connecting the R4000 to the extension module R4010, to expand the number of zones to 12 or 16 zones. Serial bus. The connecting cable must be shielded.
Permissible operating conditions	Operating: 0...50°C / 32...122°F Temperature: -30...70°C / -22...158°F Storage temperature: KWF DIN 40040; equivalent to annual average Climate class: max. 75% rel. humidity, no condensation
CE - mark	EN 61326-1:2013 / EN 61000-3-2:2006+A1:2009+A2:2009 EN 61000-3-3:1995+A1:2001+A2:2005 Electrical safety: EN 61010-1

Subject to technical improvements.

